

■ Operating and installation instructions

REMKO LRM series

Air purifier

LRM 350, LRM 500





Read these operating instructions carefully before commissioning / using this device!

These instructions are an integral part of the system and must always be kept near or on the device.

Subject to modifications; No liability accepted for errors or misprints!

Translation of the original

Table of contents

1	Safety and usage instructions	4
1.1	General safety notes.....	4
1.2	Identification of notes.....	4
1.3	Personnel qualifications.....	4
1.4	Dangers of failure to observe the safety notes.....	4
1.5	Safety-conscious working.....	4
1.6	Safety instructions for the operator.....	5
1.7	Safety notes for installation, maintenance and inspection work.....	5
1.8	Unauthorised modification and changes.....	5
1.9	Intended use.....	6
1.10	Warranty.....	6
1.11	Transport and packaging.....	6
1.12	Environmental protection and recycling.....	6
2	Technical data	7
2.1	Unit data.....	7
2.2	Unit dimensions.....	9
3	Design and function	10
3.1	Air purification - general operation.....	10
3.2	Unit description.....	11
4	Operation	13
5	Assembly	14
5.1	Unit transport.....	14
5.2	Setting up the unit.....	15
6	Commissioning	16
7	Shutdown	16
8	Care and maintenance	17
9	Troubleshooting and customer service	20
10	View of the unit	21
11	Spare parts list	22
12	Index	23

REMKO LRM series

1 Safety and usage instructions

1.1 General safety notes

Carefully read the operating manual before commissioning the units for the first time. It contains useful tips and notes such as hazard warnings to prevent personal injury and material damage. Failure to follow the directions in this manual not only presents a danger to people, the environment and the system itself, but will void any claims for liability.

Keep this operating manual and the refrigerant data sheet near to the units.

1.2 Identification of notes

This section provides an overview of all important safety aspects for proper protection of people and safe and fault-free operation. The instructions and safety notes contained within this manual must be observed in order to prevent accidents, personal injury and material damage.

Notes attached directly to the units must be observed in their entirety and be kept in a fully legible condition.

Safety notes in this manual are indicated by symbols. Safety notes are introduced with signal words which help to highlight the magnitude of the danger in question.

DANGER!

Contact with live parts poses an immediate danger of death due to electric shock. Damage to the insulation or individual components may pose a danger of death.

DANGER!

This combination of symbol and signal word warns of a situation in which there is immediate danger, which if not avoided may be fatal or cause serious injury.

WARNING!

This combination of symbol and signal word warns of a potentially hazardous situation, which if not avoided may be fatal or cause serious injury.

CAUTION!

This combination of symbol and signal word warns of a potentially hazardous situation, which if not avoided may cause injury or material and environmental damage.

NOTICE!

This combination of symbol and signal word warns of a potentially hazardous situation, which if not avoided may cause material and environmental damage.



This symbol highlights useful tips and recommendations as well as information for efficient and fault-free operation.

1.3 Personnel qualifications

Personnel responsible for commissioning, operation, maintenance, inspection and installation must be able to demonstrate that they hold a qualification which proves their ability to undertake the work.

1.4 Dangers of failure to observe the safety notes

Failure to observe the safety notes may pose a risk to people, the environment and the units. Failure to observe the safety notes may void any claims for damages.

In particular, failure to observe the safety notes may pose the following risks:

- The failure of important unit functions.
- The failure of prescribed methods of maintenance and repair.
- Danger to people on account of electrical and mechanical effects.

1.5 Safety-conscious working

The safety notes contained in this manual, the existing national regulations concerning accident prevention as well as any internal company working, operating and safety regulations must be observed.

1.6 Safety instructions for the operator

The operational safety of the units and components is only assured providing they are used as intended and in a fully assembled state.

This unit can be used by children above the age of 8, as well as by people with impaired physical, sensory or mental capabilities or a lack of experience and knowledge if they are supervised or have received instruction in the safe operation of the unit, and if they understand the associated potential hazards. Children must never play with the unit. Cleaning and user maintenance must not be carried out by unsupervised children.

- The units and components may only be set up, installed and maintained by qualified personnel.
- If the mains power supply line of this unit is damaged, this must be replaced by the manufacturer or their customer services department or a similarly qualified person in order to avoid any hazard.
- Do not operate units or components with obvious defects or signs of damage.
- The units may not be installed or operated in explosive environments.
- The units must not be installed or operated in atmospheres containing oil, sulphur, chlorine or salt.
- The units must be installed upright and in a stable position.
- The units and components must not be exposed to any mechanical load, extreme levels of humidity or extreme temperatures.
- All housing parts and unit openings, e.g. air inlets and outlets, must be free from foreign objects. An unobstructed air inlet and air outlet must be guaranteed at all times.
- The units must not be covered during operation.
- Never insert foreign objects into the units.
- The units must not be transported while they are running.

NOTICE!

Extensions to the connection cable must only be conducted by authorised specialist electricians, taking into consideration the unit power consumption, cable length and local use.

DANGER!

Work on the electrical equipment must only be conducted by an authorised specialist!

1.7 Safety notes for installation, maintenance and inspection work

- Appropriate hazard prevention measures must be taken to prevent risks to people when performing installation, repair, maintenance or cleaning work on the units.
- The setup, connection and operation of the units and its components must be undertaken in accordance with the usage and operating conditions stipulated in this manual and comply with all applicable regional regulations.
- If the mains power supply line of this unit is damaged, this must be replaced by the manufacturer or their customer services department or a similarly qualified person in order to avoid any hazard.
- The units must be installed upright and in a stable position.
- The units must not be exposed to direct jets of water, e.g. pressure washers etc.
- Safety devices may not be modified or bypassed.
- The units and components may only be set up, installed and maintained by qualified personnel.
- Do not operate units or components with obvious defects or signs of damage.
- The units may not be installed or operated in explosive environments.
- The units must not be installed or operated in atmospheres containing oil, sulphur, chlorine or salt.
- The units and components must not be exposed to any mechanical load, extreme levels of humidity or extreme temperatures.
- All housing parts and unit openings, e.g. air inlets and outlets, must be free from foreign objects. An unobstructed air inlet and air outlet must be guaranteed at all times.
- All electrical cables on the outside of the units must be protected against damage (e.g. by animals etc.).

1.8 Unauthorised modification and changes

Modifications or changes to units and components are not permitted and may cause malfunctions. Safety devices may not be modified or bypassed. Original replacement parts and accessories authorised by the manufacturer ensure safety. The use of other parts may invalidate liability for resulting consequences.

REMKO LRM series

1.9 Intended use

The units have been designed as air purifiers for the cleaning of air.

Any different or additional use shall be classed as non-intended use. The manufacturer/supplier assumes no liability for damages arising from non-intended use. The user bears the sole risk in such cases. Intended use also includes working in accordance with the operating and installation instructions and complying with the maintenance requirements.

Under no circumstances should the threshold values specified in the technical data be exceeded.

1.10 Warranty

For warranty claims to be considered, it is essential that the ordering party or its representative complete and return the "certificate of warranty" to REMKO GmbH & Co. KG at the time when the units are purchased and commissioned.

The warranty conditions are detailed in the "General business and delivery conditions". Furthermore, only the parties to a contract can conclude special agreements beyond these conditions. In this case, contact your contractual partner in the first instance.

1.11 Transport and packaging

The devices are supplied in a sturdy shipping container. Please check the equipment immediately upon delivery and note any damage or missing parts on the delivery and inform the shipper and your contractual partner. For later complaints can not be guaranteed.

WARNING!

Plastic films and bags etc. are dangerous toys for children!

Why:

- Leave packaging material are not around.
- Packaging material may not be accessible to children!

1.12 Environmental protection and recycling

Disposal of packaging

All products are packed for transport in environmentally friendly materials. Make a valuable contribution to reducing waste and sustaining raw materials. Only dispose of packaging at approved collection points.



Disposal of equipment and components

Only recyclable materials are used in the manufacture of the devices and components. Help protect the environment by ensuring that the devices or components (for example batteries) are not disposed in household waste, but only in accordance with local regulations and in an environmentally safe manner, e.g. using certified firms and recycling specialists or at collection points.



2 Technical data

2.1 Unit data

Unit data LRM 350

Series		LRM 350
Version		Local air purifier with quadruple filtration
Max. cleaning performance	m ³ /h	300
Filter stages		Nylon pre-filter, filter foam mat, activated carbon granulate cassette, HEPA filter
HEPA filter separation efficiency	%	99.975
Operating range	°C/r.H.%	+5 to +50/35 to 75
Power supply	V/Ph/Hz	230/1~/50
Enclosure class		IP20

Fan stage		Sleep	1	2	3
Room area application area, per stage	m ²	-	15-20	20-28	28-35
Air flow volume per stage setting	m ³ /h	101	150	210	325
Power consumption, per stage	W	5	8	11	40
Max. current consumption	A	0.04	0.07	0.1	0.29
Sound pressure level, per stage ¹⁾	dB(A)	28	39	45	59
Sound power level, per stage	dB(A)	36	47	53	67

Series		LRM 350
Dimensions		
Height	mm	617
Width	mm	400
Depth	mm	190
Weight	kg	6.8
Standard colour		White, similar to RAL 9003
EDP no.		1620350

¹⁾ Distance 1 m free field

We reserve the right to modify the dimensions and design as part of the ongoing technical development process.

REMKO LRM series

Unit data LRM 500

Series		LRM 500
Version		Local air purifier with quadruple filtration
Max. cleaning performance	m ³ /h	450
Filter stages		Nylon pre-filter, filter foam mat, activated carbon granulate cassette, HEPA filter
HEPA filter separation efficiency	%	99.975
Operating range	°C/r.H.%	+5 to +50/35 to 75
Power supply	V/Ph/Hz	230/1~/50
Enclosure class		IP20

Fan stage		Sleep	1	2	3
Room area application area, per stage	m ²	-	20-30	30-40	40-50
Air flow volume per stage setting	m ³ /h	130	210	290	457
Power consumption, per stage	W	5	8	14	57
Max. current consumption	A	0.04	0.07	0.15	0.36
Sound pressure level, per stage ¹⁾	dB(A)	29	40	45	59
Sound power level, per stage	dB(A)	37	48	53	67

Series		LRM 500
Dimensions		
Height	mm	682
Width	mm	440
Depth	mm	190
Weight	kg	9.7
Standard colour		White, similar to RAL 9003
EDP no.		1620500

¹⁾ Distance 1 m free field

We reserve the right to modify the dimensions and design as part of the ongoing technical development process.

2.2 Unit dimensions

LRM 350

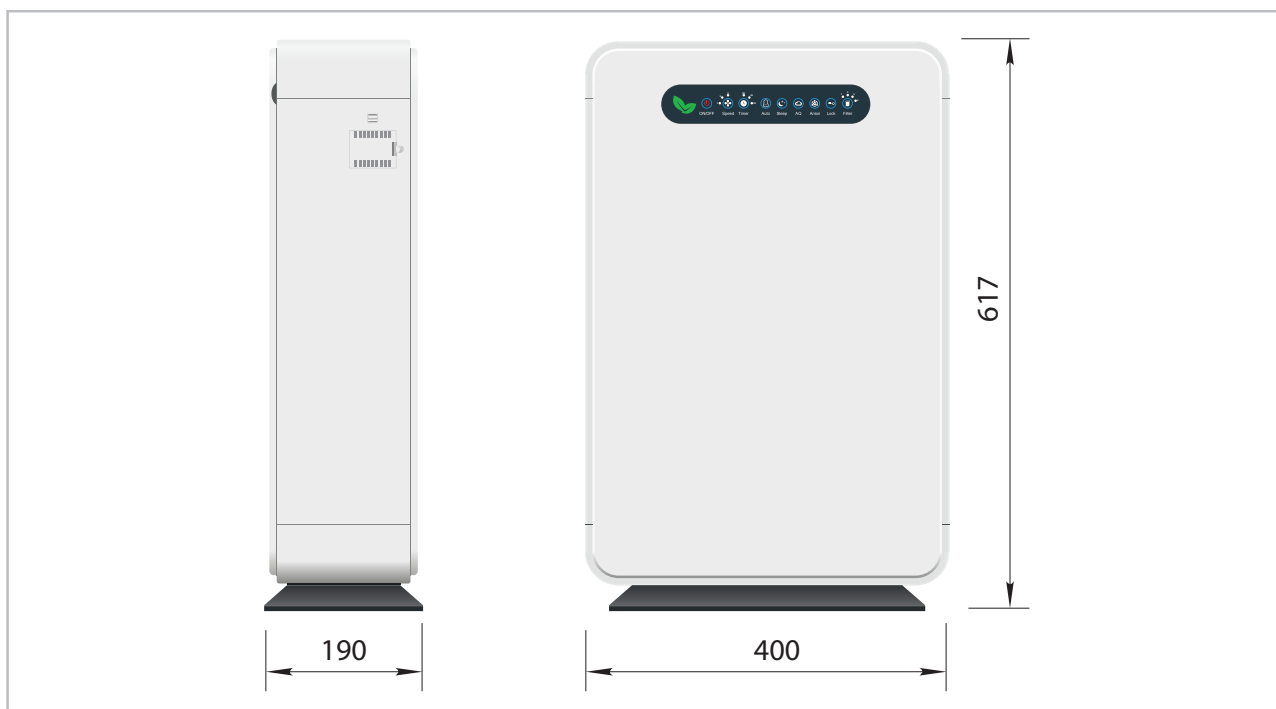

Fig. 1: Unit dimensions LRM 350 (all measurements in mm)

LRM 500

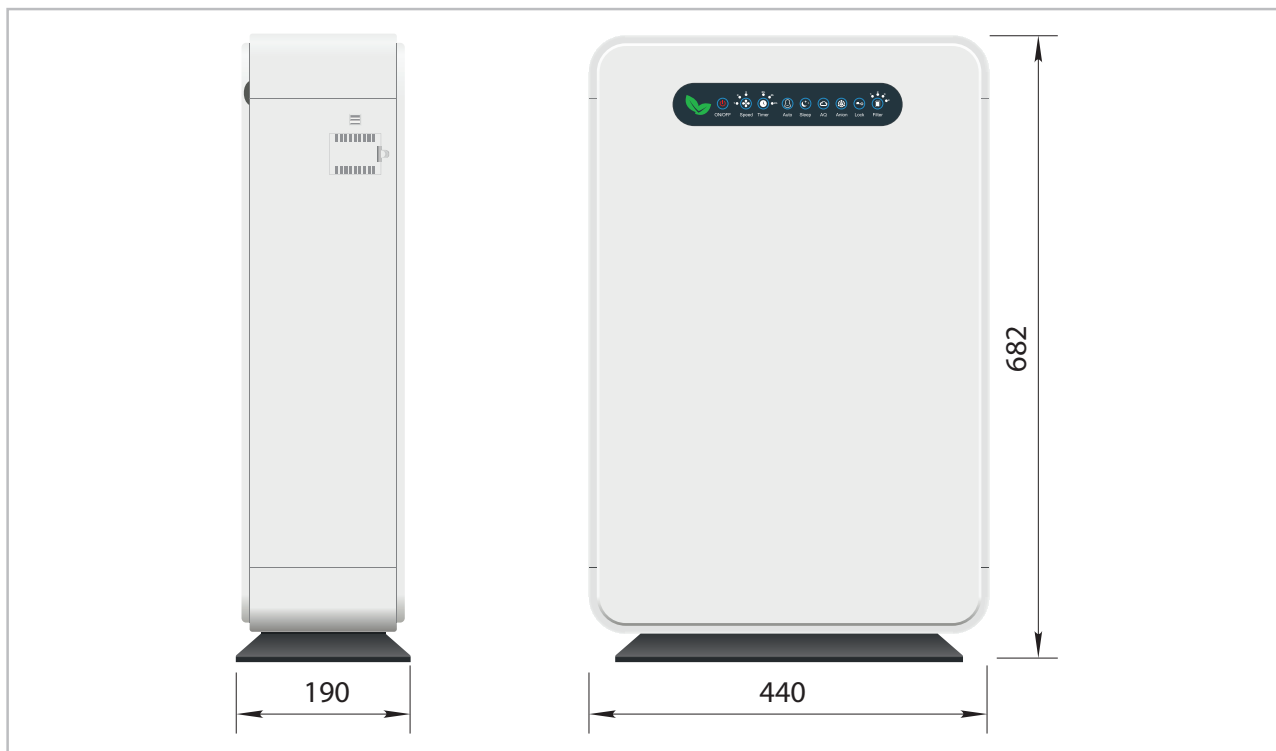

Fig. 2: Unit dimensions LRM 500 (all measurements in mm)

We reserve the right to modify the dimensions and design as part of the ongoing technical development process.

REMKO LRM series

3 Design and function

3.1 Air purification - general operation

The correlations occurring when air is purified are based on physical laws and effects. These are depicted here in graphical form in order to provide you with a brief overview of the principles of air purification.

The use of REMKO air purifiers

Our ambient air contains a lot of different foreign substances such as dust, fibres, pollen, germs and smoke, which are caused by various processes (combustion, agitation, abrasion, processing of materials, etc.). The particles in the air can cause various reactions in humans and the environment. The following physical effects enable these foreign substances to be filtered out of the room air.

Sieve effect

Particles that are larger than the free space between the individual filter fibres remain trapped and are thus caught by the filter.

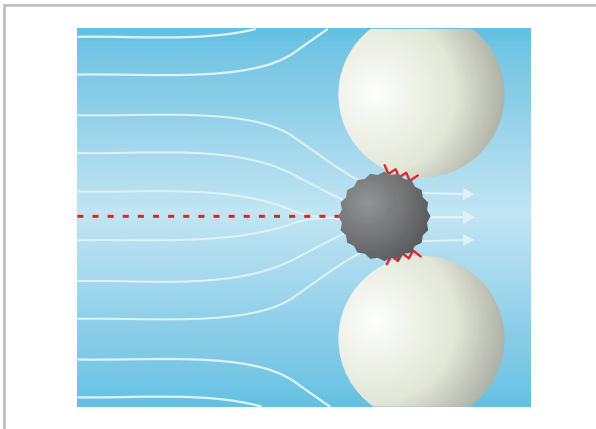

Fig. 3: Sieve effect

Barrier effect

Smaller particles follow the diverted air flow around the individual filter fibres. If the particles get too close to a filter fibre, they get caught and are prevented from further penetrating.

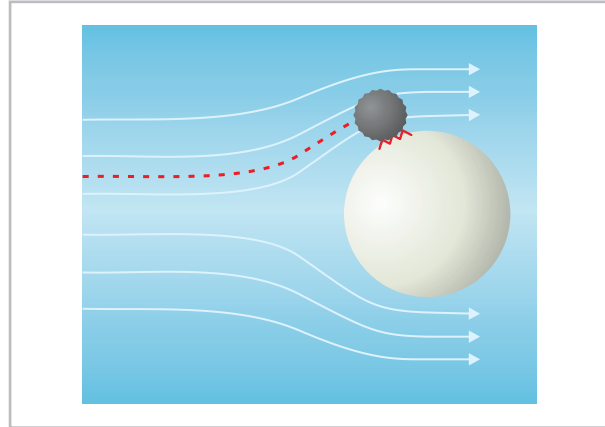

Fig. 4: Barrier effect

Inertia effect

Due to their inertia, larger particles leave their trajectory when the airflow is deflected by a filter fibre and collide directly with the filter fibre, where they finally get caught.

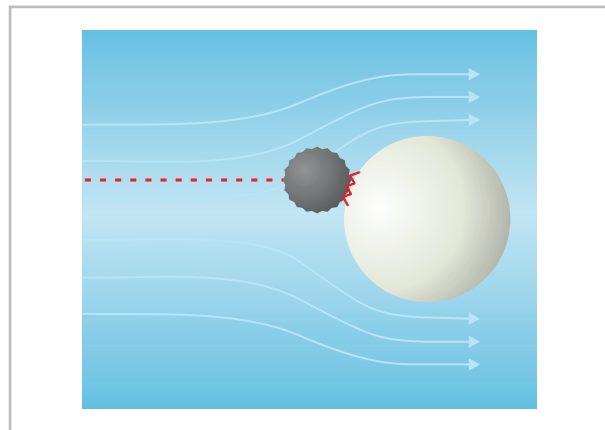

Fig. 5: Inertia effect

Diffusion effect

Very small particles (<math><1\mu\text{m}</math>) are guided by Brownian molecular motion. The particles do not follow the general air flow, but move completely at random in a zigzag pattern and eventually hit a filter fibre.

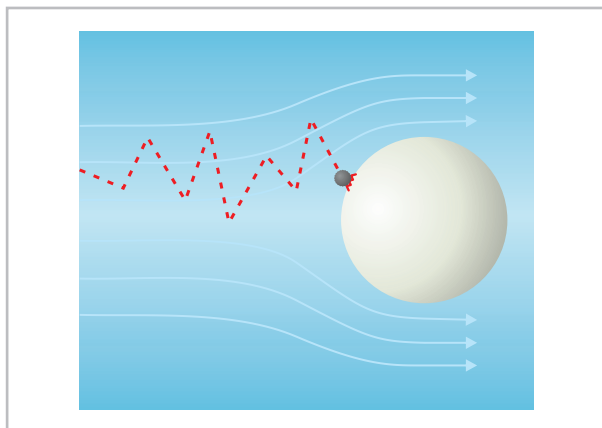

Fig. 6: Diffusion effect

Electrostatic charging

In contrast to the effects listed above, electrostatic charging does not filter the particles mechanically, but rather binds them together by generating negatively charged ions (anions). The bonded particles have a higher mass and a larger diameter, which means they can be more effectively captured by the filters.

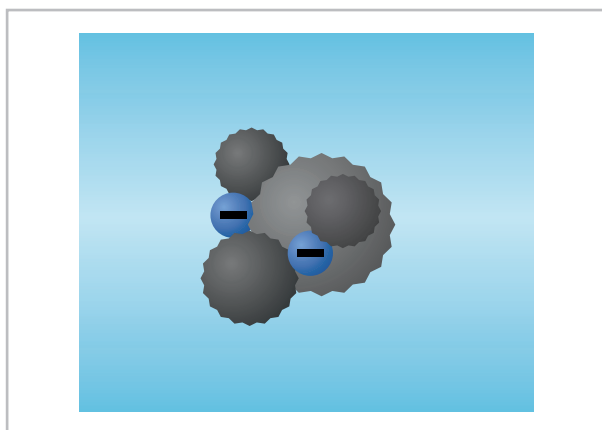

Fig. 7: Electrostatic charging

3.2 Unit description

The units have been designed for universal and straightforward air purification.

Their compact dimensions allow the unit to be transported and set up with ease.

The air purifiers of the LRM series primarily use four air filters arranged in a row for optimal air purification. Each of the four filters has its strengths in removing certain types and sizes of particles. The filters make use of various physical effects for filtering.

The units conform to the fundamental health and safety requirements of the appropriate EU regulations. The units are dependable and offer ease of operation.

The units can be used anywhere where value is placed on clean room air and a healthy room climate needs to be created.

REMKO LRM series

Unit construction

The basis is a flow-optimised housing with a centrally positioned radial fan. The room air is sucked in over a large area at the rear of the unit and drawn through the filters arranged in a row. The cleaned air is then fed back into the room via the air outlet on the top of the unit.

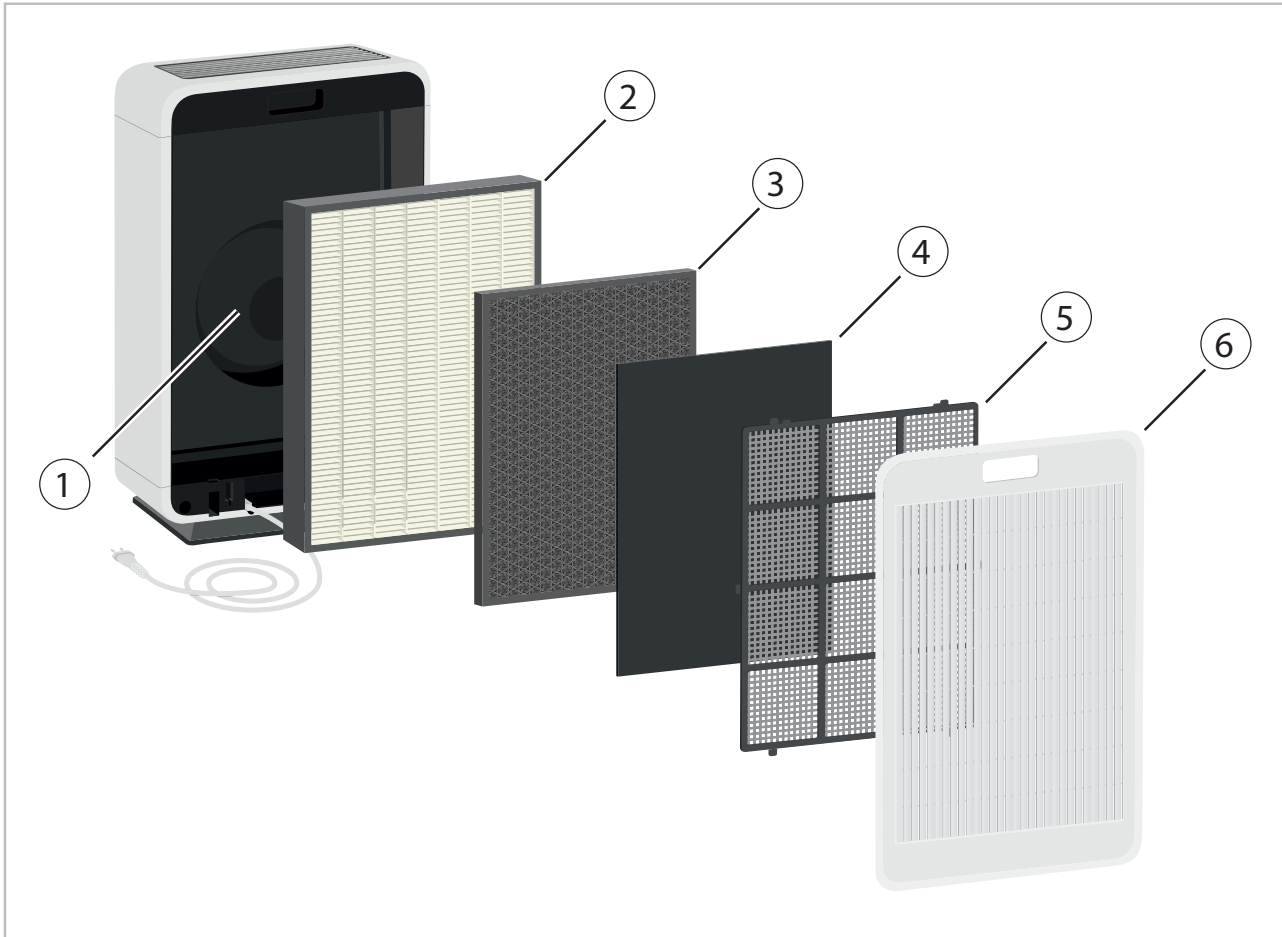

Fig. 8: Unit construction

- | | |
|--|--------------------------------|
| 1: Radial fan | 4: Filter foam mat |
| 2: HEPA filter | 5: Nylon pre-filter |
| 3: Activated carbon granulate cassette | 6: Housing cover, rear of unit |

The pre-filter traps coarse particles such as fibres, animal hair and scales to protect the downstream filters from excessive loading and premature saturation by larger particles.

Particles of medium size such as coarse dust and fine sand stick to their surface due to their inertia and the disordered structure of the filter foam mat.

The activated carbon granulate in the granulate cassette has countless microscopically small pores and capillary systems. This results in an immense inner surface from which gas molecules, vapours and odours from the air can be adsorbed.

The HEPA filter with its separation efficiency of 99.975 % removes the remaining finer particles, such as fine dust, pollen, smoke and germs from the air. In addition to the filter system, the integrated anion generator can be switched on at the push of a button.

4 Operation

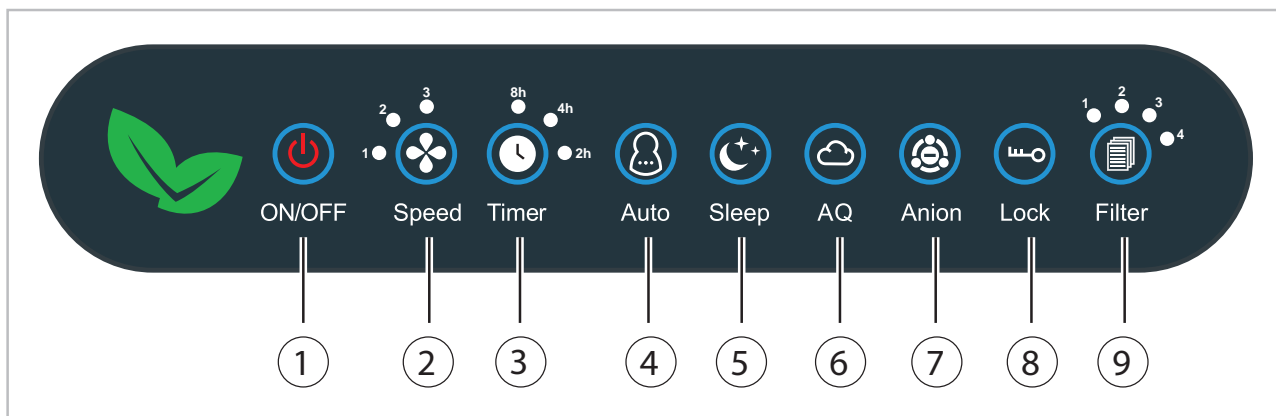

Fig. 9: Control panel

① "ON/OFF" key

This key switches the unit on and off.

② "Fan Speed" key

By pressing this key, it is possible to choose between the fan stages Low (1), Medium (2) and High (3).

③ "TIMER" key for switch-off delay

The switch-off delay can be activated with this key when the machine is switched on. It is possible to select a unit switch-off time delay of 2, 4 and 8 hours.

④ "Auto Fan" key

This key can be used to activate and deactivate the automatic fan control. When automatic fan control is activated, the unit automatically selects the fan speed based on the air quality.

⑤ "Sleep" night mode key

Pressing this key activates and deactivates night mode. When night mode is activated, the fan speed is reduced to a minimum and the control panel lighting is dimmed.

⑥ "AQ" air quality display key

Activates the air quality indicator (leaf symbol), which visualises the quality of the room air. The colours shown are to be understood as follows:

Red: poor air quality

Orange: average air quality

Green: good air quality

⑦ "Anion" generator key

This key can be used to activate and deactivate the anion generator. When the anion generator is activated, the air purifier produces anions that attract and bind suspended particles in the air. The bonded particles can be better separated by the filters due to their greater mass and increased diameter.

⑧ "Lock" key

Pressing this key activates the key lock. The key lock can be deactivated again by holding the key down.

REMKO LRM series

⑨ “Filter” filter change key

This key can be used to reset the filter cleaning or filter change message after filter cleaning or filter change has been completed. If filter cleaning or a filter change is necessary, the corresponding LED flashes. The numbered LEDs are assigned as follows:

- 1: Pre-filter
- 2: Filter foam mat
- 3: Activated carbon granulate cassette
- 4: HEPA filter

When the unit is switched on, the appropriate filter can be selected by briefly pressing the key. The selected LED lights up steadily. The filter cleaning or filter change message can be reset by pressing and holding for 3 seconds.

The operating hours counter for the filter cleaning or filter change message can also be reset if the filter was cleaned or changed prematurely and the corresponding lamp does not yet announce the change. To do this, press and hold the filter key for 3 seconds when the unit is switched off. As soon as the LEDs start flashing, the desired filter can be selected by pressing the key again. The selected filter lights up continuously.

The operating hours counter for the filter cleaning or filter change message can now be reset by pressing and holding for 3 seconds. The operation can be cancelled by pressing the On/Off key.

5 Assembly

5.1 Unit transport

The units can be transported either upright or lying down. For easy transport, the air purifiers are equipped with a transport handle in the upper part of the rear of the unit.



Fig. 10: Transport handle

The connection cable can be stowed away in the transport compartment provided for this purpose for transport and storage after removing the rear cover of the unit.



Fig. 11: Transport compartment connection cable

WARNING!

The mains cable must never be used as a pull cord or fixing device.

5.2 Setting up the unit

For the best economic and safe use of the units, the following notes must be followed in full:

- The units must be set up in an upright and level position in order to ensure unhindered operation of the unit
- It must be ensured that the air can be sucked in at the rear of the unit and blown out of the top of the unit without obstruction (min. 50 cm minimum clearance)
- Observe a minimum clearance of 20 cm from walls on all sides at all times
- Units must never be set up in the immediate vicinity of heaters or other sources of heat
- The area of application must be closed to the neighbouring atmosphere
- The output of the unit is dependent on the conditions inside the room, room temperature, relative humidity and particle emissions
- No emission sources should be located near the indoor air quality sensor. (left side of the unit)

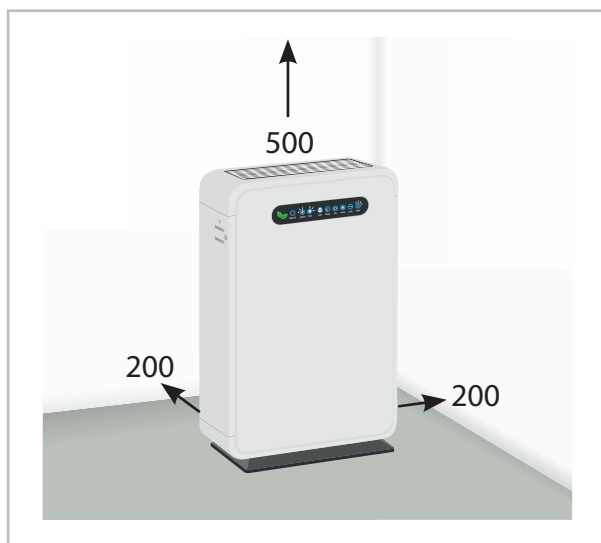

Fig. 12: Minimum clearances (all measurements in mm)



- Keep windows and doors closed!
- Keep at least 0.2 m away from walls.
- Maintain adequate clearance from heaters or other sources of heat.

The air purifier should be placed as centrally as possible in the middle of the room to achieve optimum air circulation

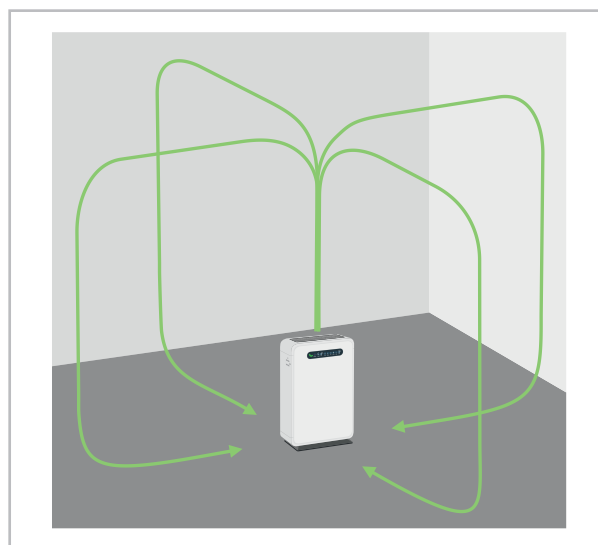

Fig. 13: Set up in the middle of the room

If it is not possible to set up the unit in the middle of the room, it can also be set up on the side of a wall.

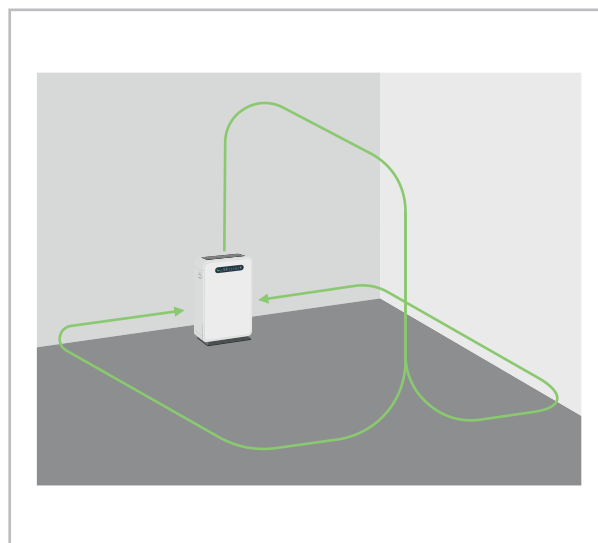

Fig. 14: Set up on the side of the room

REMKO LRM series

6 Commissioning

Initial commissioning

The air filters are shrink-wrapped in film when delivered. The filters must be removed from the unit and unpacked before initial commissioning. The procedure for removing and inserting the filters is described in the “Care and maintenance” chapter.

Important notes prior to commissioning

- All extensions to the electrical connection must be of a sufficient cable size and must only be used fully rolled out or unrolled.
- Never use the power supply connection cable as a pull cord.

! NOTICE!

Operating the unit with welded-in filters can cause damage to the internal components of the unit.

Commissioning

Start the unit as follows:

1. ► Plug the unit's power plug into a properly installed and fused mains socket (230V/50 Hz).

If you connect the air purifier to the mains, the unit should be switched off (not operating). The operating unit emits an acoustic signal.
2. ► Actuate the “ON/OFF” key. The operating unit emits an acoustic signal. The “ON/OFF” button lights up to indicate that the unit is activated.
3. ► Select the desired operating parameters on the operating panel.

Automatic restart after power failure:

If the electrical power fails or if the power plug is pulled out during operation, the unit switches off. When the power source is restored or when the plug is plugged in again, the unit restarts automatically with the saved settings.

7 Shutdown

If the air purifier is to be deactivated, this can be done either manually using the “ON/OFF” key on the operating panel or automatically using the pre-set switch-off delay (“Timer” key).

! NOTICE!

If a shutdown with a longer service life is planned, it is recommended to dispose of the filters for reasons of hygiene and to replace them when they are put back into operation.

8 Care and maintenance

Filter maintenance intervals

There are 4 LEDs on the operating element, each assigned to a filter stage. The individual LEDs light up after a defined operating time has elapsed and thus indicate the required filter cleaning or filter change. The prompt is displayed sooner or later, depending on user behaviour. For orientation purposes, the following running times can be assumed.

Filter stage	Equivalent to			Measure
	24h/d	18h/d	12h/d	
Nylon pre-filter	30 days	45 days	60 days	Cleaning
Filter foam mat	90 days	135 days	180 days	Replacement
Activated carbon granulate cassette	180 days	270 days	360 days	
HEPA filter	180 days	270 days	360 days	

If usage is less than an average of 12 hours a day, the filters should nevertheless be cleaned or replaced at the latest after 60 days (nylon pre-filter), 180 days (filter foam mat) and 360 days (activated carbon granulate cassette & HEPA filter).

General information on care and maintenance

DANGER!

Care and maintenance work may only be carried out if the unit is disconnected from electrical power.

- Observe the regular care and maintenance intervals
- Never subject to direct jets of water (**e.g. pressure washers etc.**)
- Never use abrasive or solvent-based cleaners
- Even with heavy contamination, use only suitable cleaners.
- Regularly check the air inlet and outlet area for dirt
- Put the unit out of operation 60 minutes before planned work on the filters



When handling used filters, make sure that you take adequate health protection measures (disposable gloves, mouth/nose protection). If possible, carry out the work outside the usage time of the room in question.

Removing and inserting the filters

The filters can be removed from the unit and replaced as follows:

1.  Pull carefully on the recesses provided in the upper part of the housing cover. Then lift the housing cover out of the brackets on the underside of the unit and set it aside

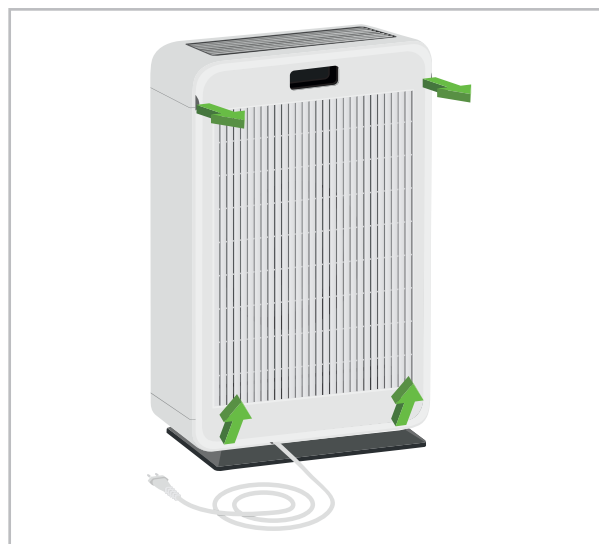

REMKO LRM series

2. ➤ Pull the nylon pre-filter out of the unit by the tabs. Pay attention to the retaining tabs on the sides and on the lower edge

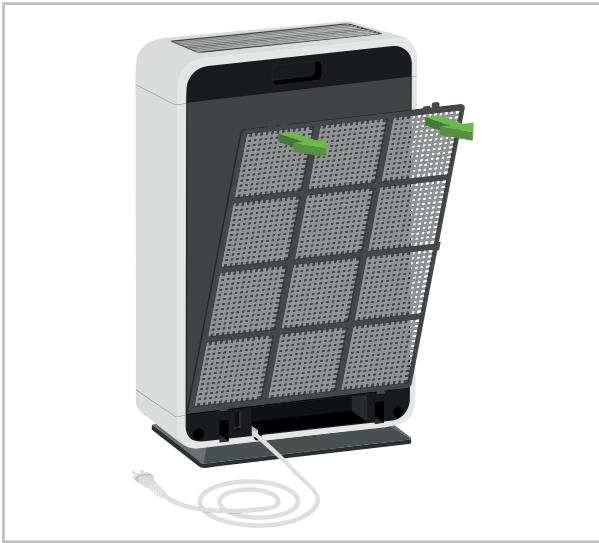

4. ➤ Pull the granular activated carbon cartridge out of the unit by the tab.

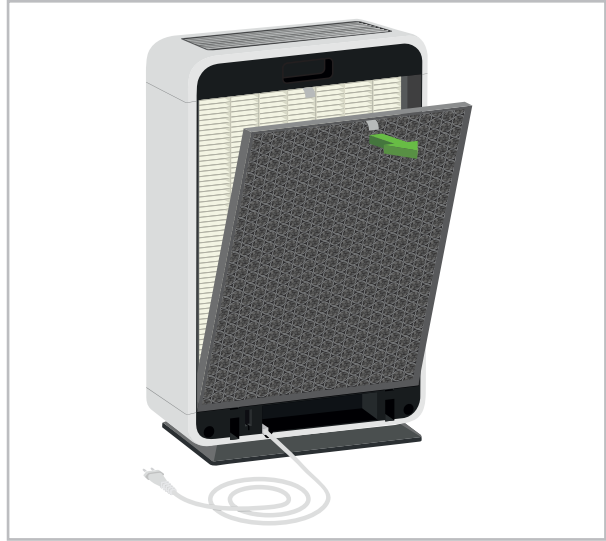

3. ➤ Pull the filter foam mat attached with Velcro strips off the activated carbon granulate cassette.



5. ➤ Pull the HEPA filter out of the unit by the tab.



To insert the filters into the unit, proceed in reverse order. Insert the filters so that the tabs are accessible and the numbering (except the filter foam mat) remains visible.

Cleaning the pre-filter

The pre-filter consists of a nylon fabric that prevents coarse particles such as hair and dust flakes from further entering the following filters. The pre-filter can either be cleaned carefully with a vacuum cleaner or with lukewarm water.

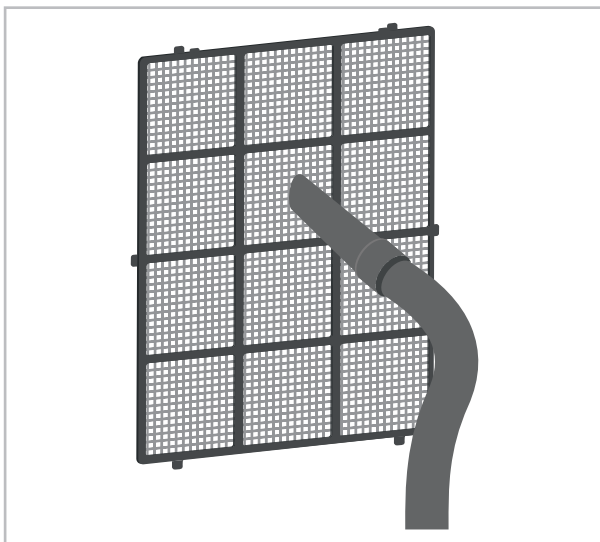

Fig. 15: Cleaning the pre-filter with a vacuum cleaner

Heavier contamination may be remedied by rinsing the filter in a lukewarm (max. 40°C) soap solution. Finally, always rinse the filter carefully with clear water and allow to dry.

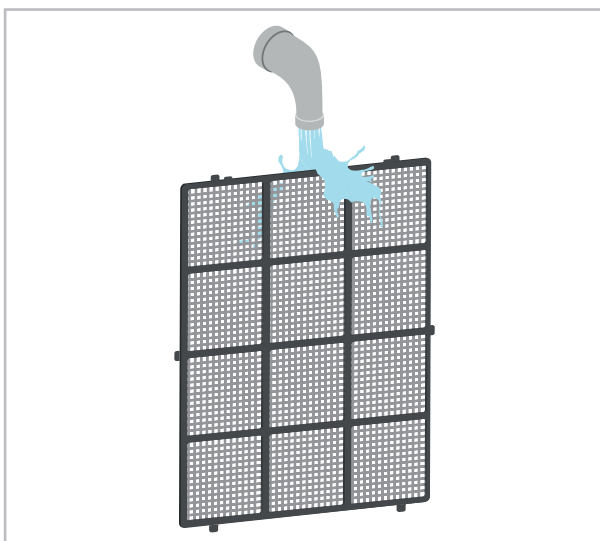

Fig. 16: Clean the pre-filter with lukewarm tap water

Before refitting the dust filter, ensure that its fully dry and that no damage has been sustained.

Replacing the after-filters

The filter foam mat, the activated carbon granulate cassette and the HEPA filter cannot be regenerated. After removal, the filters must be disposed of and replaced with new original filters. Handle used filters with care and dispose of them as soon as possible to prevent particles from separating from the filter media and getting back into the room air. If the used filters cannot be disposed of immediately, it is advisable to store the filters in airtight sealed packaging until final disposal.



Do not bend, fold or knock out the used filters on any other object. The particles released in the process can pose a health risk if inhaled.



As a rule, the used filters can be disposed of in household waste. If harmful substances have been filtered with the filters, it may be necessary to dispose of the filters as hazardous waste. If in doubt, enquire about local regulations and laws.

Cleaning the units

The units should be cleaned regularly both outside and inside the filter housing. Use gentle cleaning agents and clean the unit with a soft cloth. How often the unit needs to be cleaned depends heavily on the usage pattern and should always be checked.



Fig. 17: Cleaning the filter housing

REMKO LRM series

9 Troubleshooting and customer service

The unit and components are manufactured using state-of-the-art production methods and tested several times to verify that they function correctly. However, if malfunctions should occur, please check the functions as detailed in the list below. For systems with an indoor unit and outdoor unit, refer to the chapter "Troubleshooting and customer service" in both operating manuals. Please inform your dealer if the unit is still not working correctly after all function checks have been performed!

Operational malfunctions

Malfunction	Possible causes	Remedial measures
The unit does not start or switches itself off	Power failure	Check the voltage and if necessary, wait for it to come back on
	Defective mains fuse	Arrange to have exchanged
	Damaged power supply	Repair by specialist firm
	Switch-off delay (timer function)	
	Housing cover (rear of unit) opened	Close the housing cover
The unit cannot be operated	Key lock active	Deactivate key lock
Operating panels do not light up	Sleep function active	Deactivate sleep function
Air quality display remains red even after long periods of operation	Emission source near the sensor	Remove emission source or relocate unit



DANGER!

Work on the electrical equipment must only be conducted by an authorised specialist!

10 View of the unit

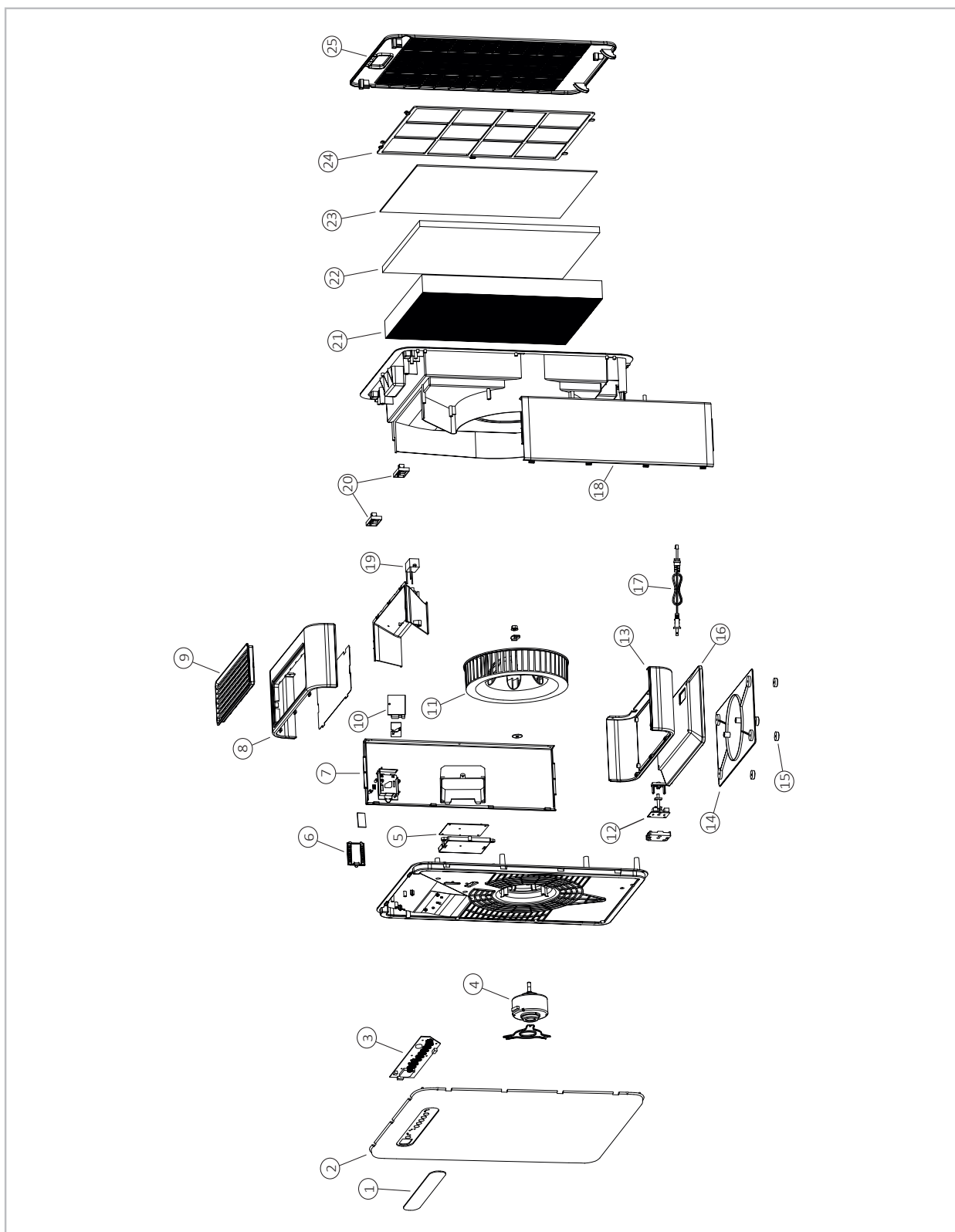

Fig. 18: Exploded view LRM 350, LRM 500

REMKO LRM series

11 Spare parts list

No.	Designation	LRM 350	LRM 500
1	Operating panel film		
2	Housing front		
3	Operating board		
4	Fan motor		
5	Control board		
6	Maintenance flap air quality sensor		
7	Housing side, left		
8	Housing top section		
9	Air outlet finned grille		
10	Air quality sensor		
11	Fan wheel		
12	Housing cover microswitch		
13	Housing floor		
14	Base plate		
15	Rubber foot		
16	Pedestal		
17	Power plug		
18	Housing side, right		
19	Anion generator		
20	Housing cover latching clip		
21	HEPA filter		
22	Activated carbon granulate cassette		
23	Filter foam mat		
24	Nylon pre-filter		
25	Housing cover, rear of unit		

On request, please specify
the serial number

12 Index

C

Care and maintenance	17
Commissioning	16
Customer service	20

D

Disposal of equipment	6
-----------------------------	---

E

Environmental protection	6
Exploded view	21

M

Malfunctions	
Checks	20
Possible causes	20
Remedial measures	20

O

Operation	
Control panel	13

S

Safety	
Dangers of failure to observe the safety notes	4

General	4
Identification of notes	4
Note for inspection work	5
Note for installation work	5
Note for maintenance work	5
Notes for the operator	5
Personnel qualifications	4
Safety-conscious working	4
Unauthorised modification	5
Unauthorised replacement part manufacture ..	5
Setting up the unit	15
Shutdown	16
Spare parts list	22

T

Troubleshooting and customer service	20
--	----

U

Unit data LRM 350	7
Unit data LRM 500	8
Unit description	11
Unit dimensions	9
Unit transport	14

W

Warranty	6
----------------	---

REMKO QUALITY WITH SYSTEMS

Air-Conditioning | Heating | New Energies

REMKO GmbH & Co. KG
Klima- und Wärmetechnik

Im Seelenkamp 12
32791 Lage

Telephone +49 (0) 5232 606-0
Telefax +49 (0) 5232 606-260

E-mail info@remko.de
URL www.remko.de

Hotline within Germany
+49 (0) 5232 606-0

Hotline International
+49 (0) 5232 606-130

